

VT - 100T

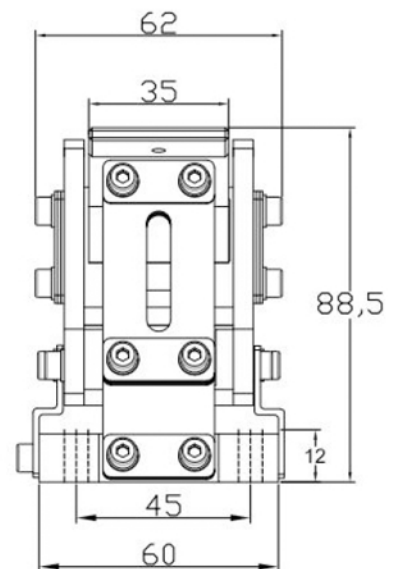
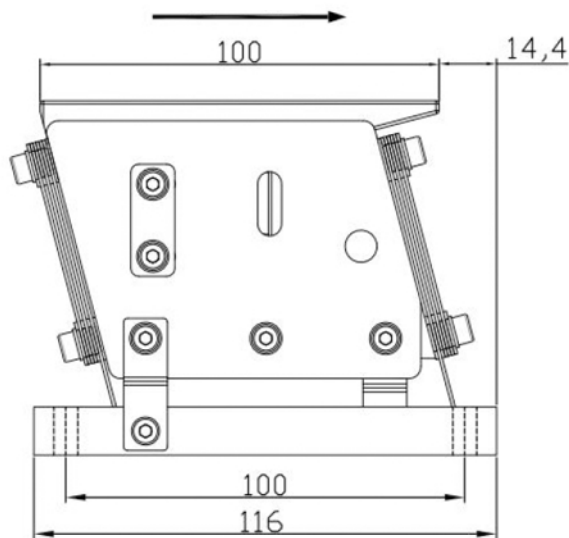
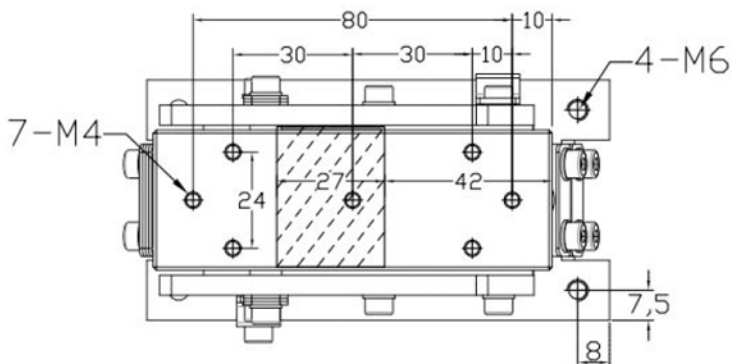

Model	Supply voltage V	Output Current A	Maximum Power W	Loading KG	Length of feed path mm	Material channel width mm
VT - 100T	220	0.11	22	<1	<350	<35