

VT - 160T

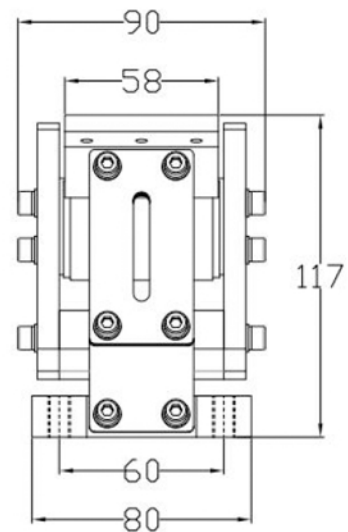
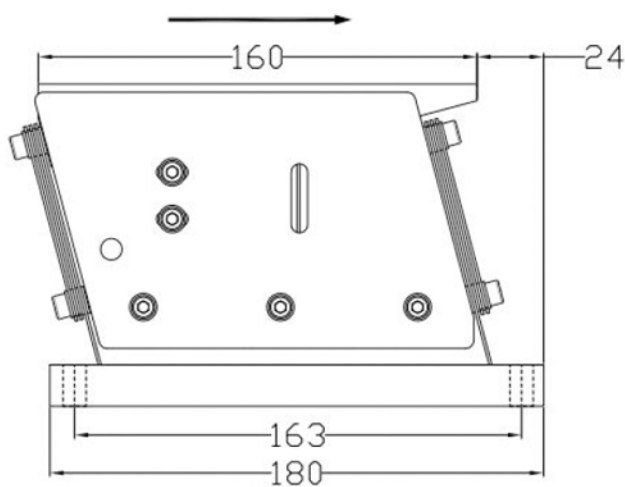
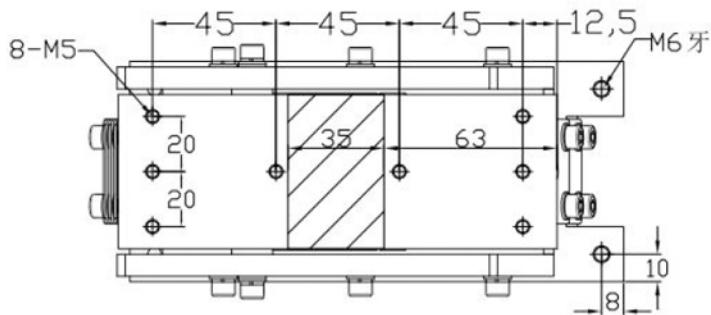

Model	Supply voltage V	Output Current A	Maximum Power W	Loading KG	Length of feed path mm	Material channel width mm
VT - 160T	220	0.65	131	<3	<550	<60