

VT - 190T

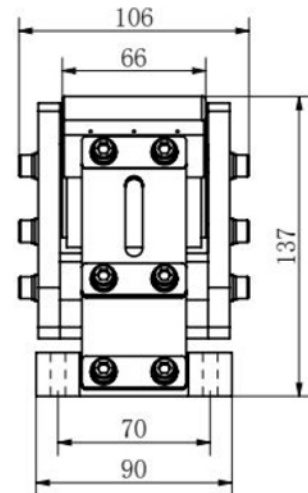
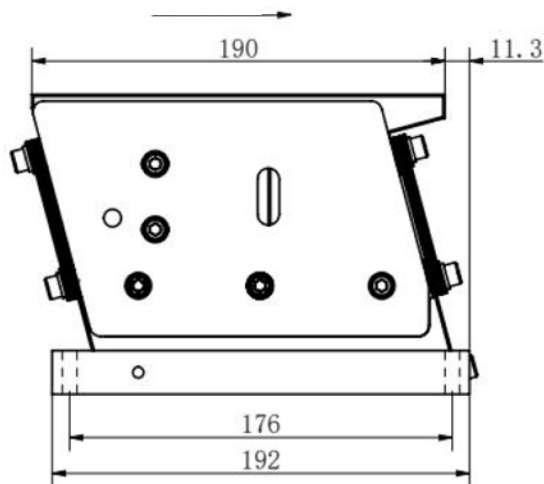
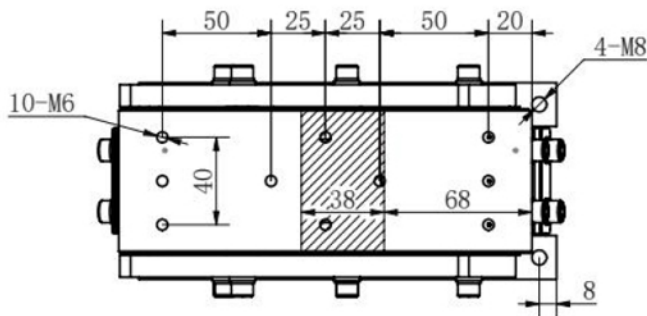

Model	Supply voltage V	Output Current A	Maximum Power W	Loading KG	Length of feed path mm	Material channel width mm
VT - 190T	220	0.7	140	<4	<600	<90