

VT - 140Z

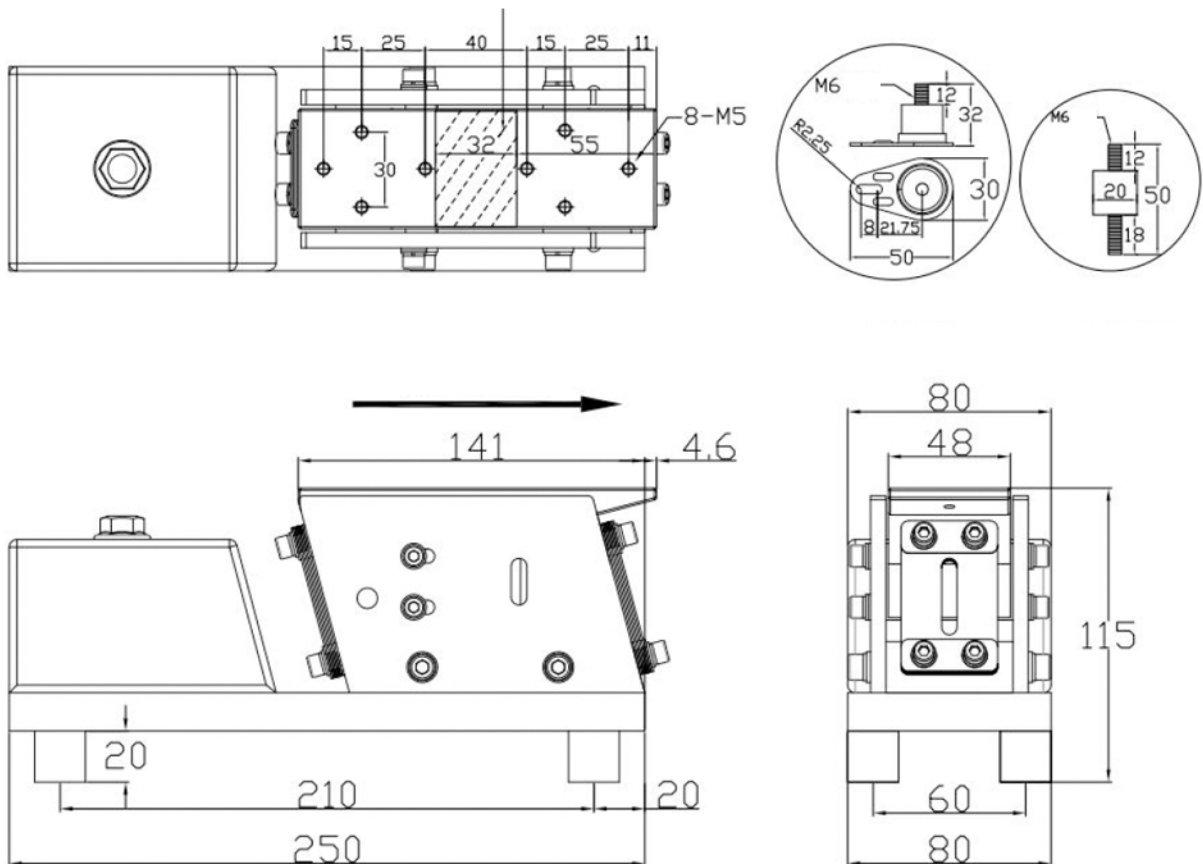
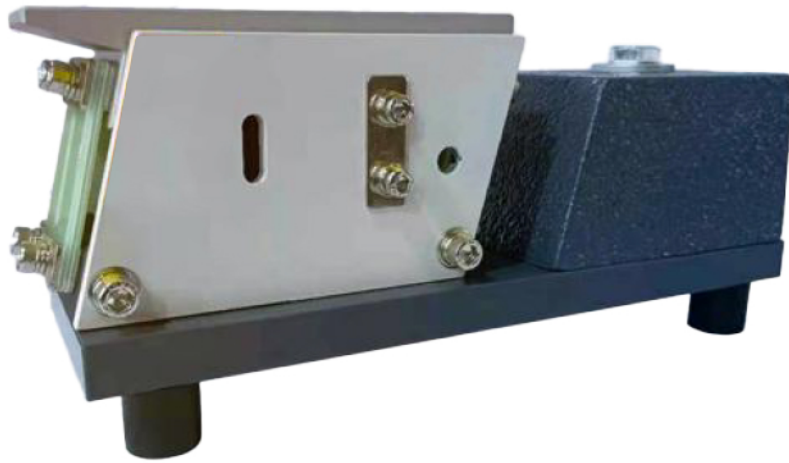

Model	Tensiune de alimentare V	Curent de iesire A	Putere maxima W	Încărcare KG	Lungime cale de avans mm	Lățime canal material mm
VT - 140Z	220	0.28	56	<4	<500	<80