

VT - 140Z

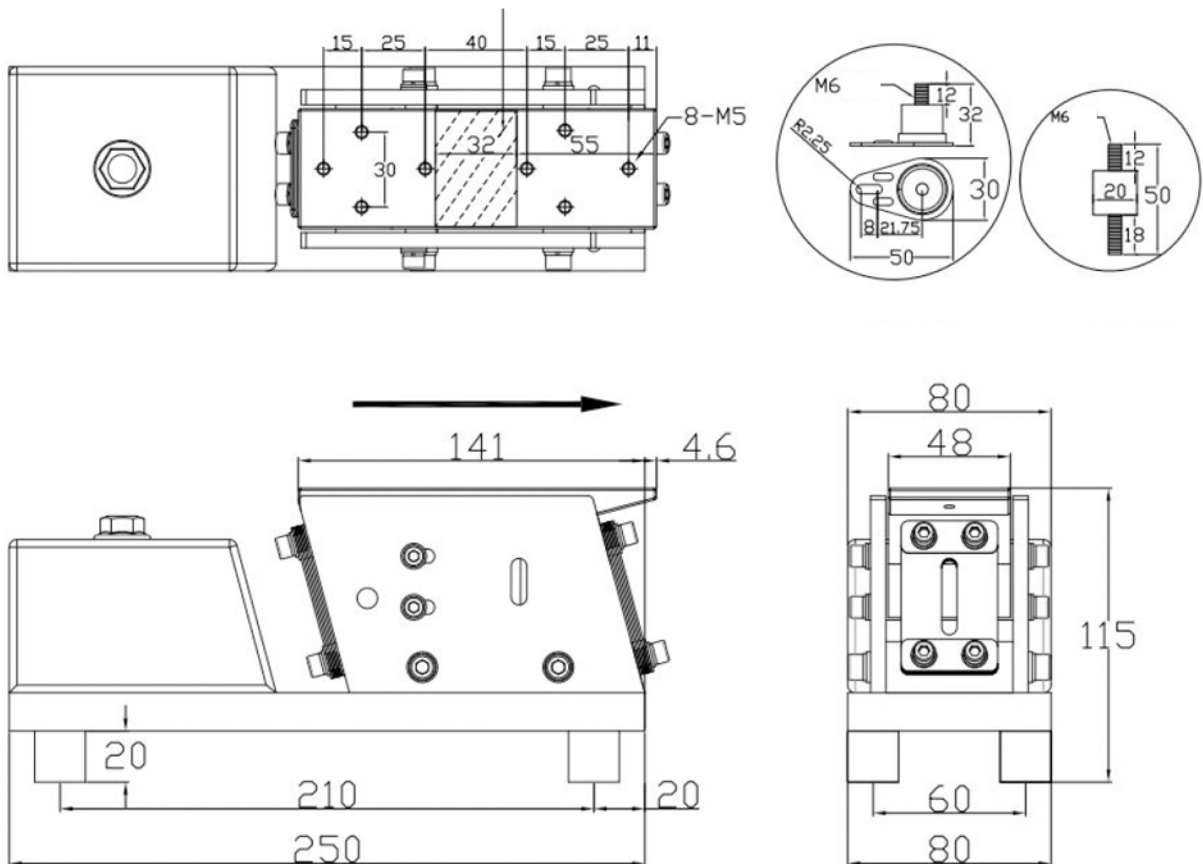
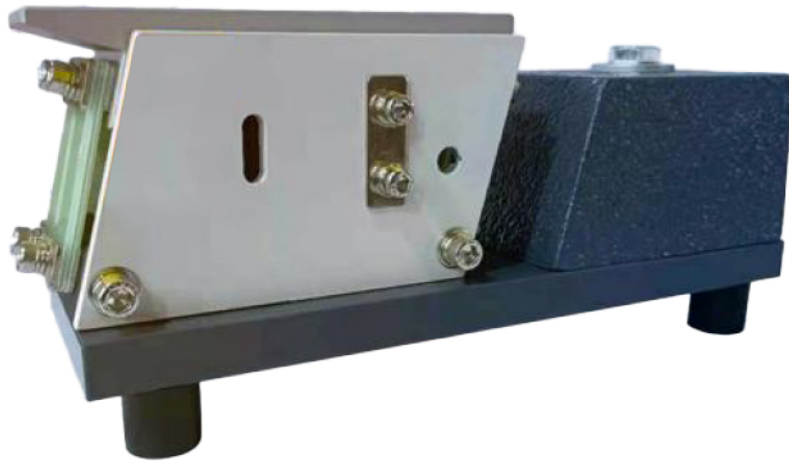

Model	Supply voltage V	Output Current A	Maximum Power W	Loading KG	Length of feed path mm	Material channel width mm
VT - 140Z	220	0.28	56	<4	<500	<80