

VT - 160Z

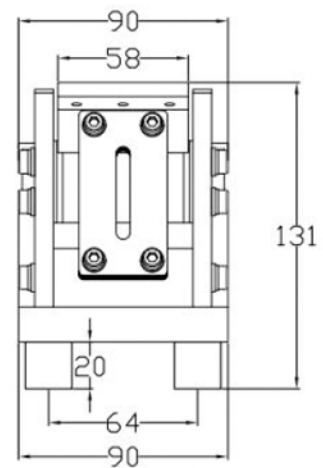
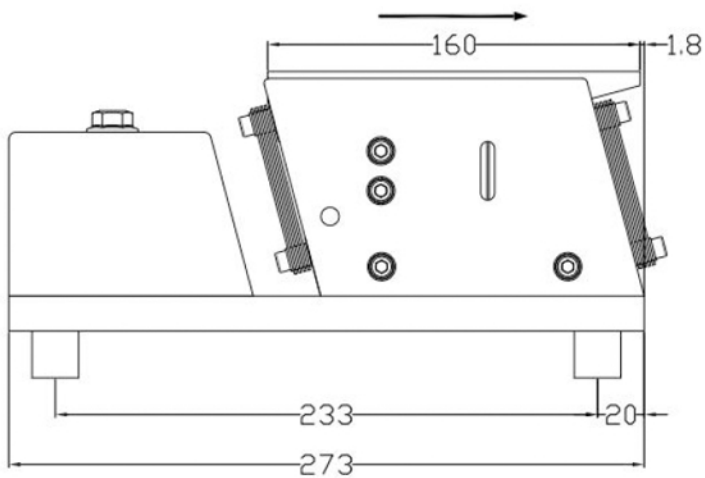
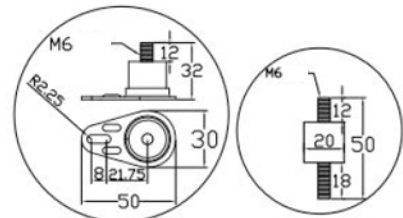
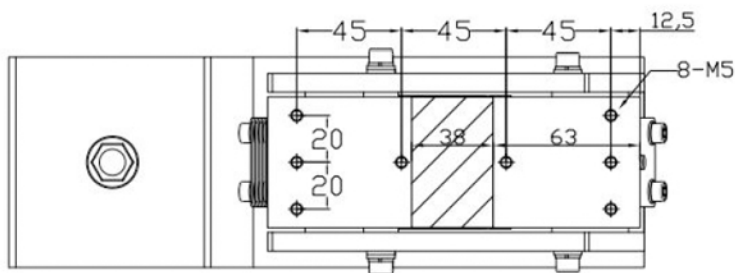

Model	Tensiune de alimentare V	Curent de iesire A	Putere maxima W	Încărcare KG	Lungime cale de avans mm	Lățime canal material mm
VT - 160Z	220	0.65	131	<6	<600	<85