

VT - 160Z

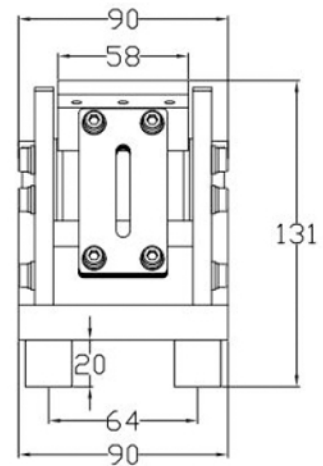
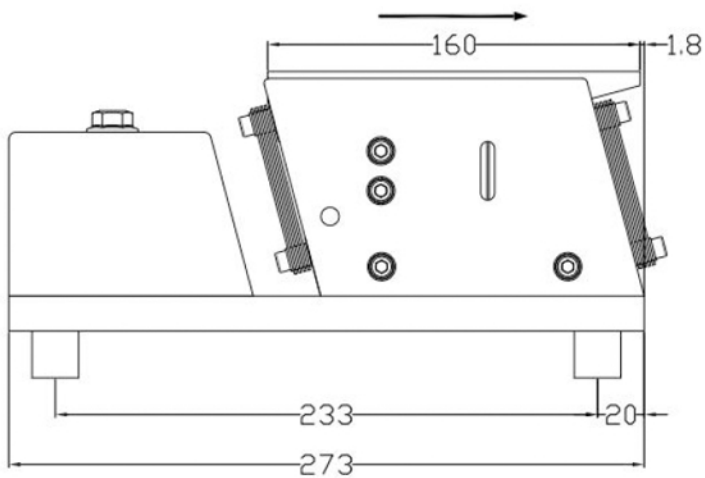
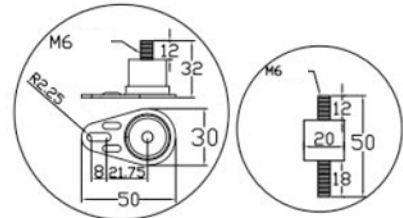
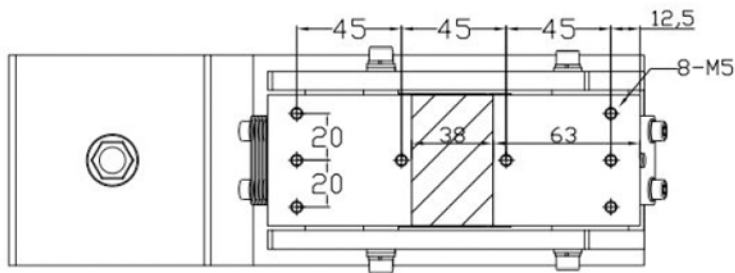

Model	Supply voltage V	Output Current A	Maximum Power W	Loading KG	Length of feed path mm	Material channel width mm
VT - 160Z	220	0.65	131	<6	<600	<85