

VT - 190Z

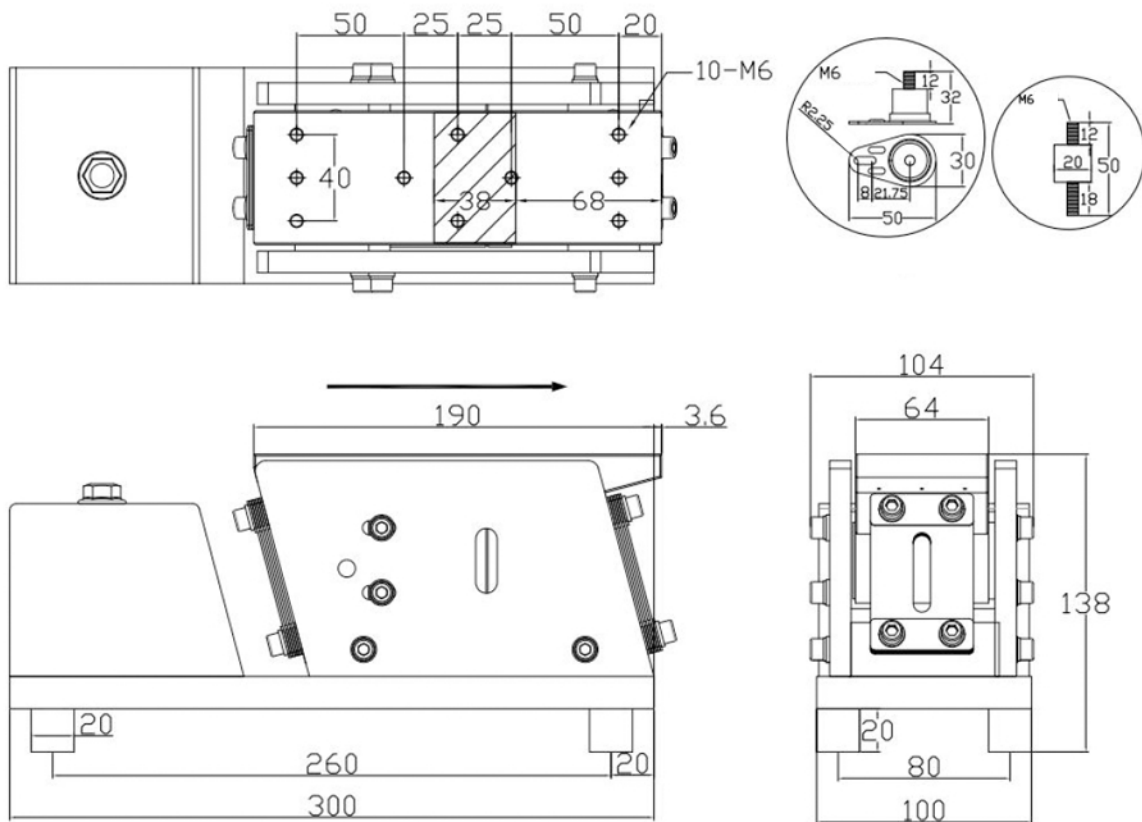

Model	Tensiune de alimentare V	Curent de iesire A	Putere maxima W	Încărcare KG	Lungime cale de avans mm	Lățime canal material mm
VT - 190Z	220	0.7	140	<10	<650	<90