

VT - 190Z

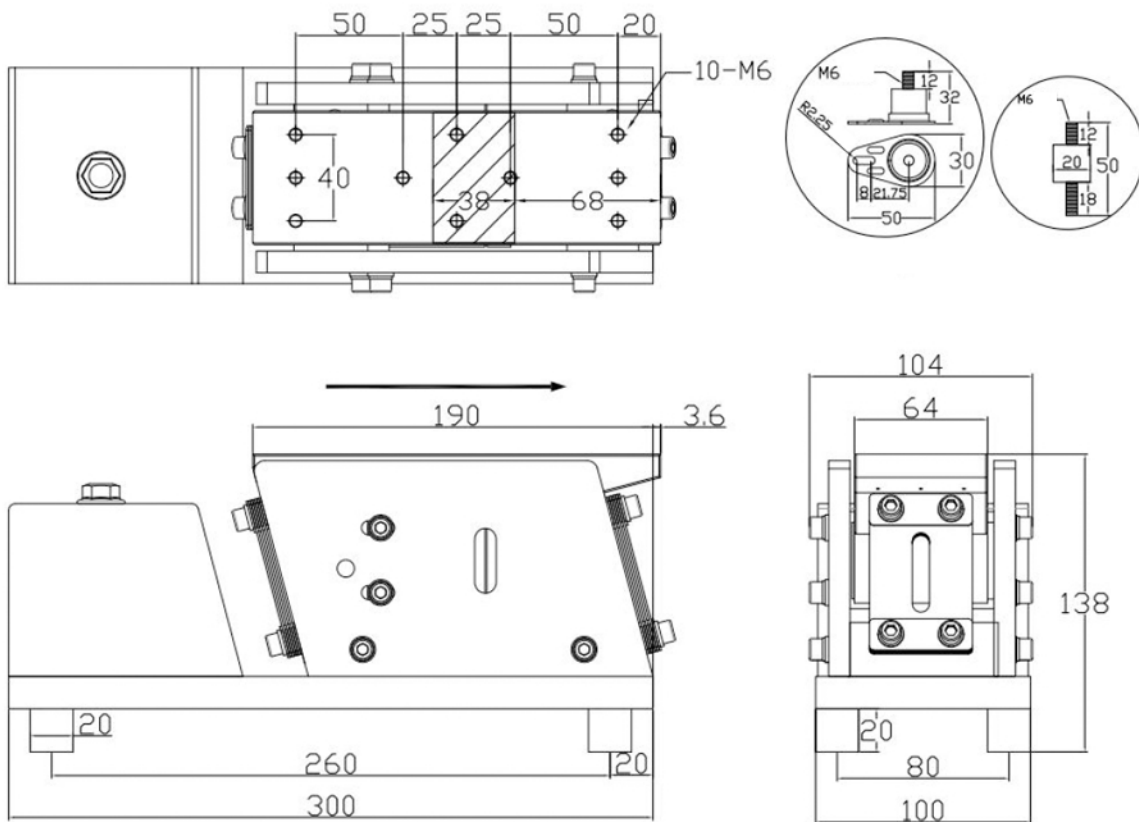

Model	Supply voltage V	Output Current A	Maximum Power W	Loading KG	Lenght of feed path mm	Material channel width mm
VT - 190Z	220	0.7	140	<10	<650	<90