

VT - 200Z

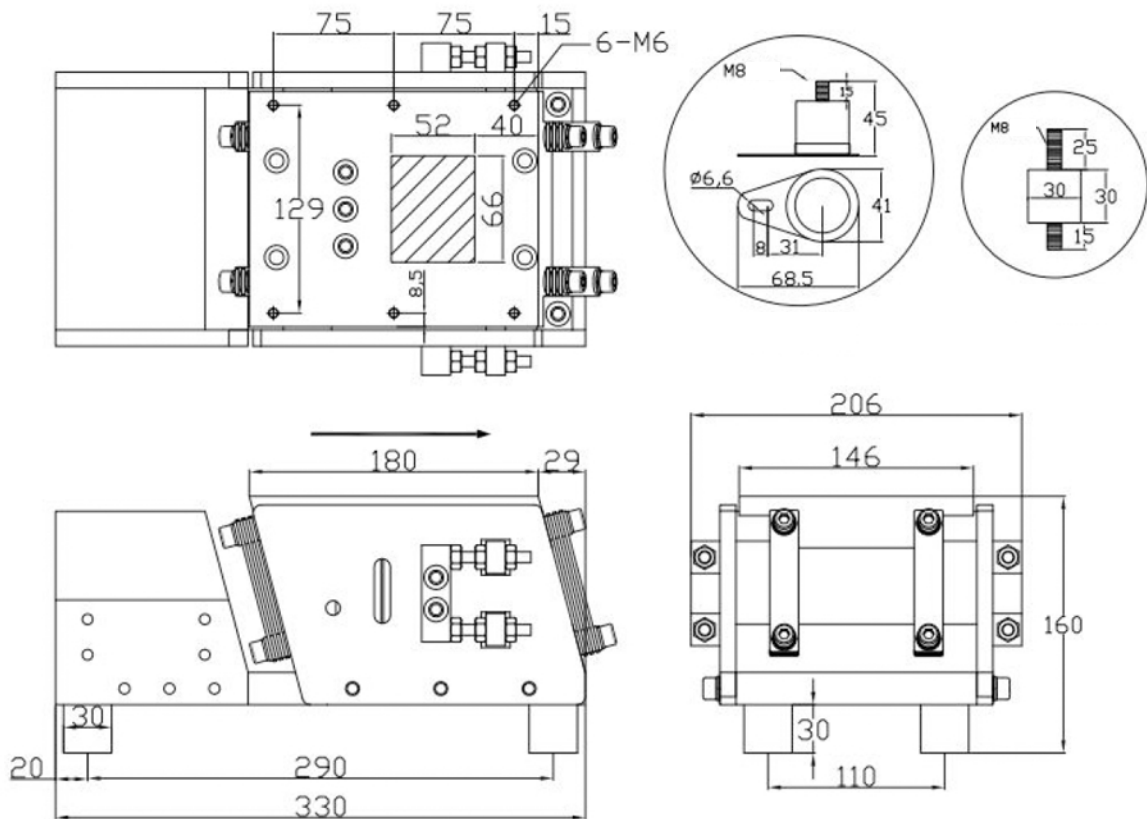

Model	Tensiune de alimentare V	Curent de iesire A	Putere maxima W	Încărcare KG	Lungime cale de avans mm	Lățime canal material mm
VT - 200Z	220	1.51	302	<20	<700	<150