

VT - 350D

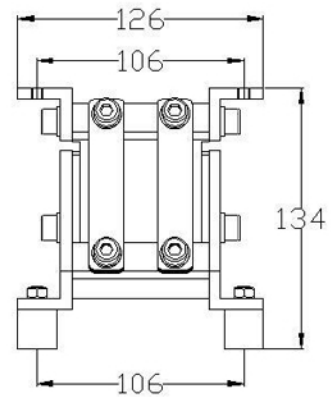
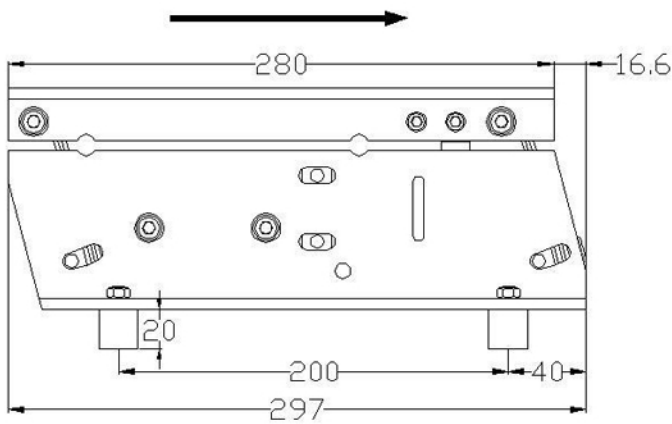
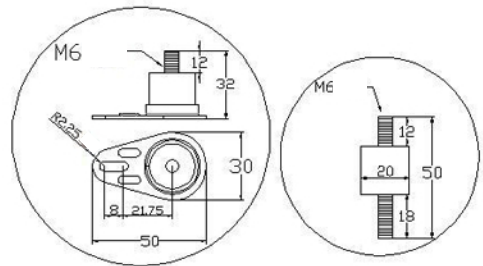
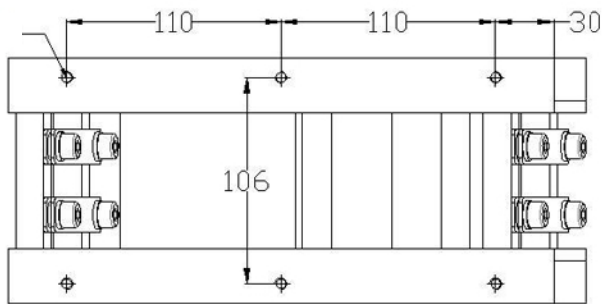

Model	Supply voltage V	Output Current A	Maximum Power W	Loading KG	Length of feed path mm	Material channel width mm
VT - 350D	220	0.68	136	<5	<700	<180