

VT - 50L

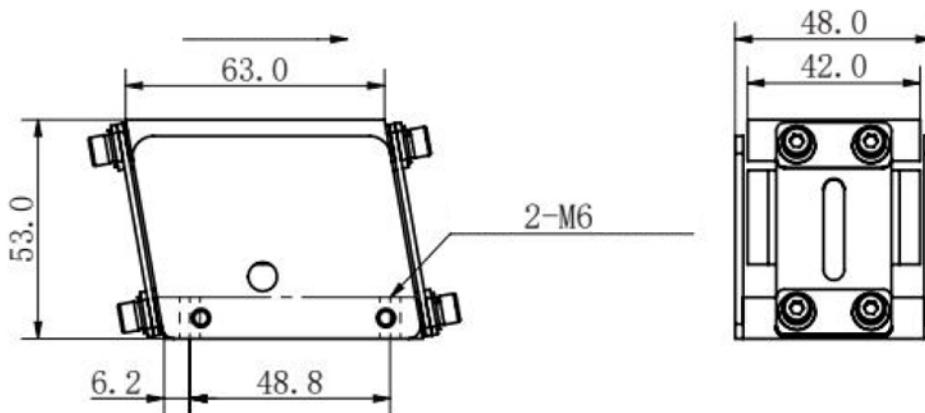
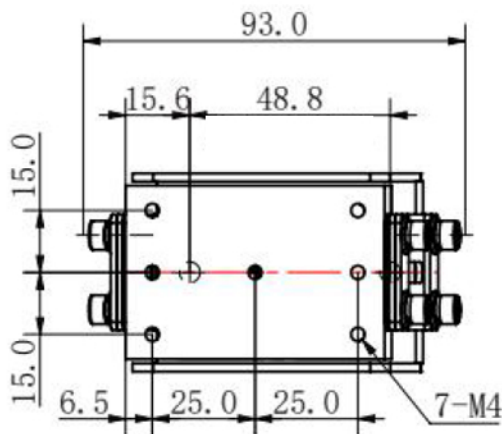

Model	Supply voltage V	Output Current A	Maximum Power W	Loading KG	Length of feed path mm	Material channel width mm
VT - 50L	220	0.25	50	<2	<220	<30