

VT - YD70

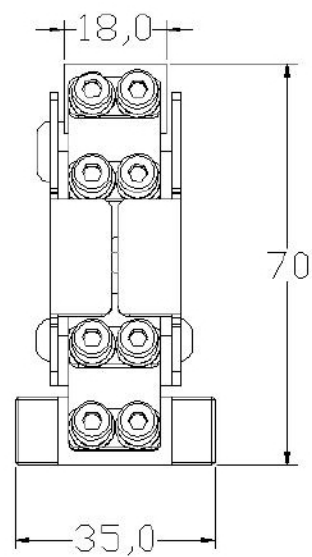
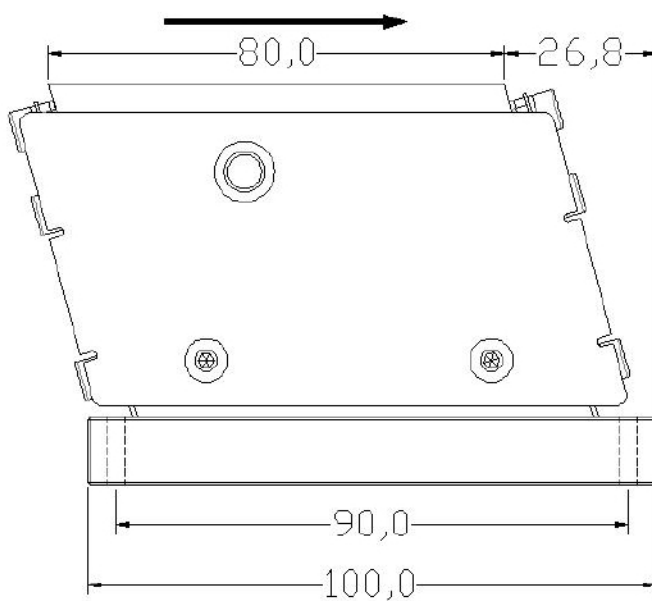
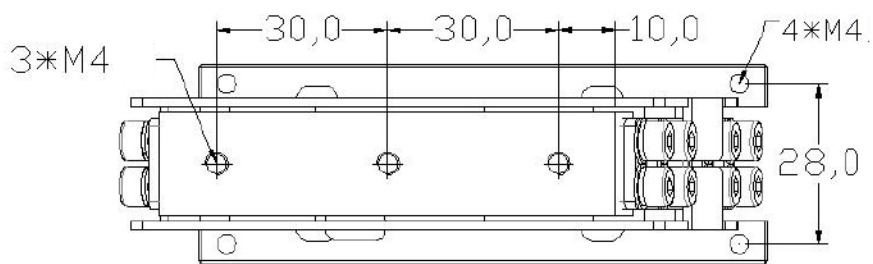

Model	Supply voltage V	Drive Source	Frequency Hz	Loading KG	Length of feed path mm	Material channel width mm
VT - YD70	<180	PIEZOELECTRIC	100-200	<0.15	<230	<25